

Data Sheet



Article number: 2011461650

Description: E+G Stainless steel lock pin
GN 114.6-16-50

Measures

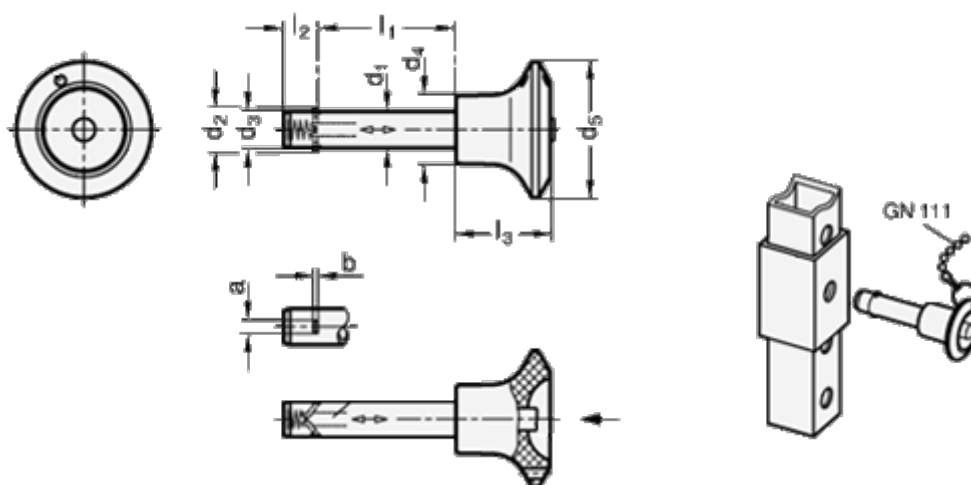

a = 113.0	l3 = 32
d1 = 16	Resilience (N) = 5
d2 = 19.9	
d3 = 15.9	
d4 = 22.0	
d5 = 40	
l1 = 50	
l2 = 14.2	